

# The DeltaGrip® System

## Safety and Operating Instructions

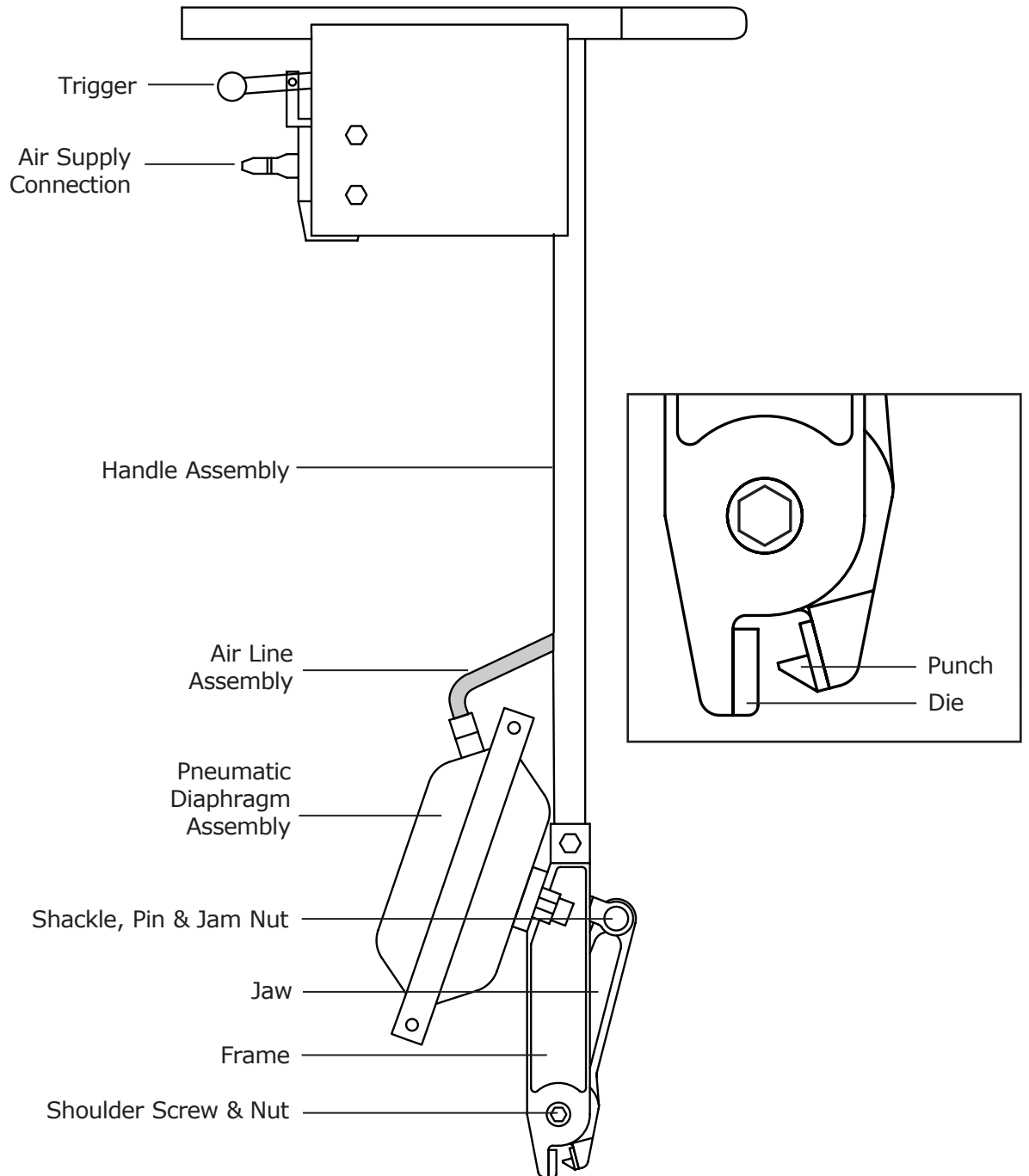



# The ASC DeltaGrip Tool

## General Safety Precautions

1. Read and understand instruction manual before operating the tool.
2. Keep work area clean and uncluttered.
3. Keep visitors away from the work area.
4. Store idle tools. When not in use, tools should be stored in a dry location.
5. Use tool for its intended purpose only.
6. Wear safety glasses.
7. Do not wear loose clothing or jewelry when operating the tool. Wear protective hair covering to contain long hair. Rubberized gloves and non-skid footwear are recommended.
8. Do not overreach. Keep proper footing and balance at all times.
9. Use proper stance and make sure footing is secure.
10. Maintain tools with care. Keep tools clean for better and safer performance.
11. Check for damaged parts. Damaged parts should be properly repaired or replaced by a qualified person.
12. Use only ASC Steel Deck replacement parts when servicing.
13. Use only recommended accessories.
14. Stay alert when operating tool.
15. Stop operating tool if something appears to be wrong.
16. Keep finger off trigger when you are not ready to punch.
17. Do not connect/disconnect hose when finger is on the trigger.
18. Allow only authorized people to use the pneumatic tools.
19. Pay attention to those around you – never permit horseplay around or with the tool.
20. Maintain proper tool assembly – do not make any modifications
21. Follow correct maintenance procedures
22. Check tool before each use.
23. Keep tool out of reach of children.
24. Never exceed maximum air pressure.
25. Make sure hose is securely fastened into the coupler and that the air fitting is securely seated in the tool.
26. Use only compressed air – using any other kind of gas mixture is dangerous.
27. In elevated locations secure air hose to a point near the location where you are working to avoid tool pulling operator off structure.
28. Do not walk backwards while using the tool.
29. Do not use tool while under the influence of drugs, alcohol, medication or while impaired.
30. Disconnect air supply from tool before doing maintenance.
31. Keep hands and feet away from moving parts.
32. Disconnect air supply hose when tool is unattended.

# Operating Instructions

1. Ensure that the tool is complete and in working order with all parts secure.
2. Set air pressure regulator on your compressor to the recommended pressure for the gauge of metal deck you are punching, prior to connecting to DeltaGrip tool.
3. Make sure hands and feet are clear of the jaw before attaching air supply hose to DeltaGrip tool.
6. Place jaw over deck standing seam side lap. Be sure the tool is perpendicular to the metal deck and the tool is in contact with the deck bottom flange and oriented as shown. (see Figure 1)
7. Actuate tool by pulling trigger. Depress trigger until the jaw fully closes to ensure a full punch. (see Figure 2)
8. Inspect completed punch for correct offset of the DeltaGrip interlock. If the offset is not sufficient increase the air pressure to achieve a full punch. Do not exceed 145 psi. (see Figure 3)

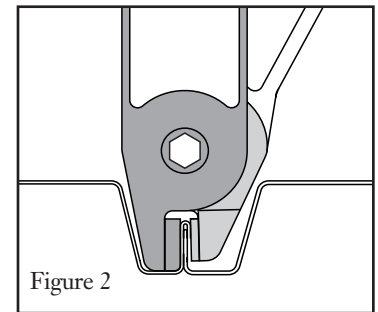
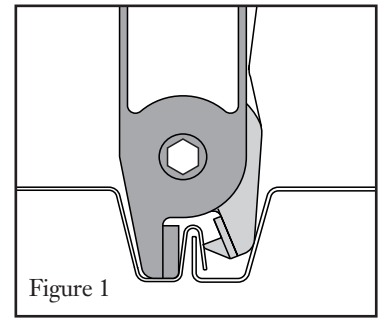

Deck Gauge	Recommended Air Pressure
20, 21, 22	90 psi
18, 19	100 psi
16	135 psi

Note: 145 psi maximum pressure

4. Attach air supply hose to tool.
5. Actuate tool once, without punching deck, to verify that the jaw closes fully.

9. For technical assistance, contact ASC Steel Deck at 800-726-2727.

Deck Gauge	Minimum Offset
20, 21, 22	0.19 inches
16, 18, 19	0.16 inches

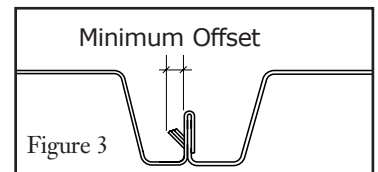

## Minimum Recommended Equipment

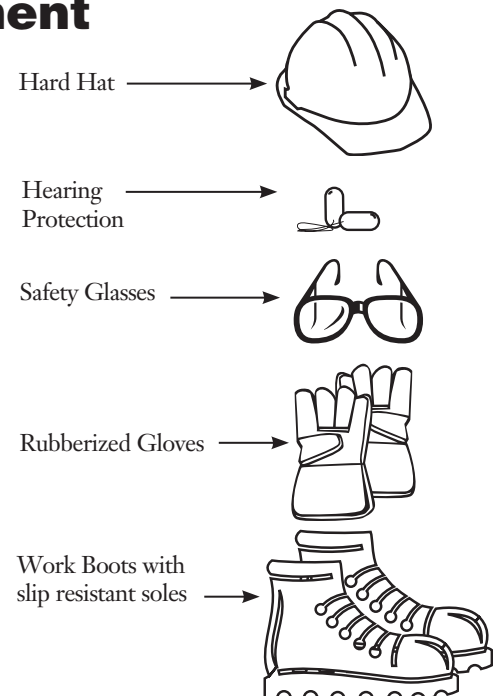
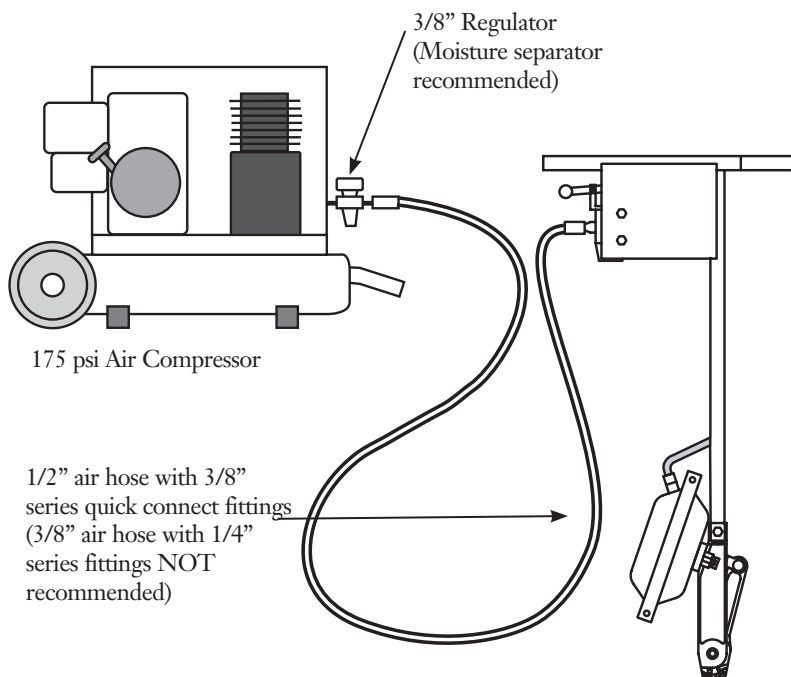

# Change Punch & Die Inserts

1. Disconnect the air supply hose from DeltaGrip tool.
2. Use hex key to remove flat head cap screws holding die or punch to tool jaw or frame. (see Figure 4)
3. Install new die or punch using new screws provided.
4. Make sure die is securely installed on the frame and the punch is installed on the rotating jaw.
5. Connect air supply hose. Set air compressor to 15psi. Actuate tool to ensure punch and die clears.
6. Return to air recommended operating pressure setting and follow operating instructions for usage of the tool.

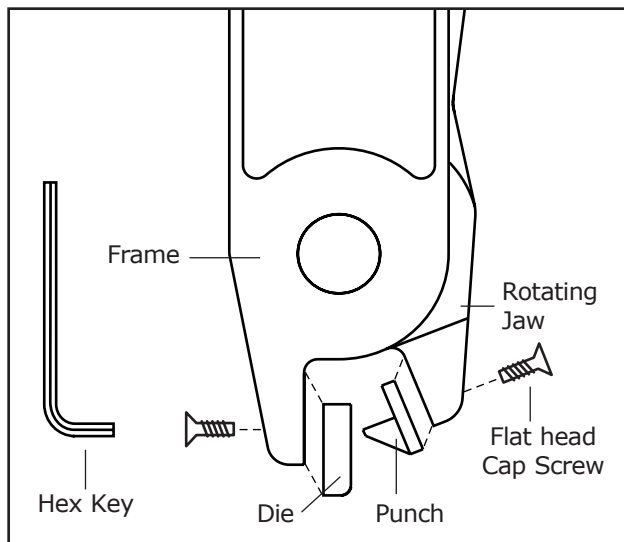
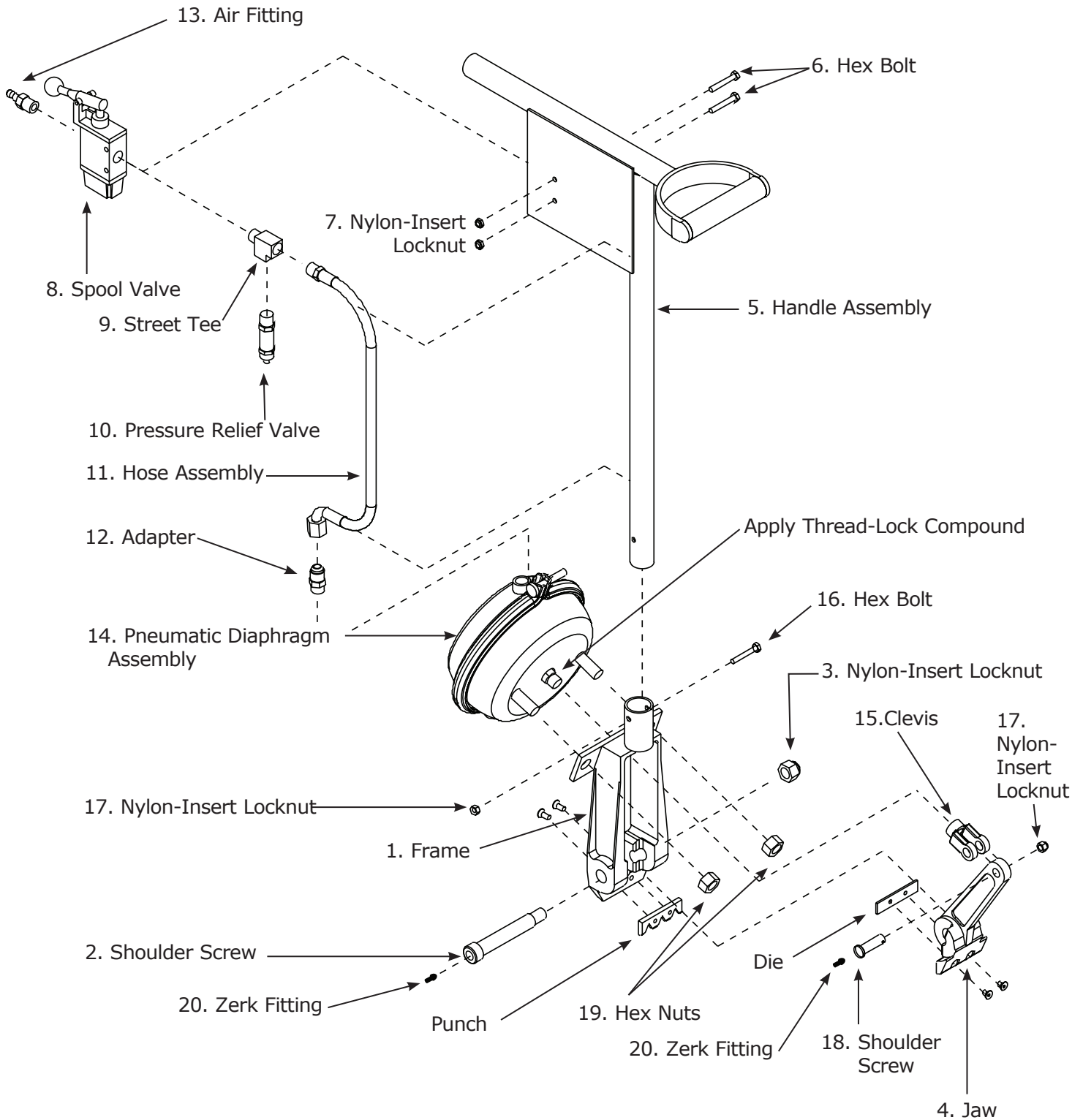

Figure 4

# DeltaGrip Tool Parts List

Part No.	Part Name
1.	Frame
2.	1"Øx3 NC Shoulder Screw
3.	5/8 NC Nylon-Insert Locknut
4.	Jaw
5.	Handle Assembly
6.	1/4Øx2 NC Hex Bolt Grade 5
7.	1/4 NC Nylon-Insert Locknut
8.	Spool Valve
9.	3/8 NPT Brass Street Tee
10.	3/8 NPT Pressure Relief Valve, 145 psi
11.	Hose Assembly
12.	3/8 NPT to 37° Brass Adapter
13.	3/8 NPT Air Fitting (3/8" tru-flat series)
14.	Pneumatic Diaphragm Assembly
15.	Forged Clevis
16.	3/8Øx2 NC Hex Bolt Grade 5
17.	3/8 NC Nylon-Insert Locknut
18.	1/2Ø Shoulder Screw
19.	5/8 NC Hex Nuts
20.	1/4-28 Short Zerk Fitting

# Diagram of DeltaGrip Parts



# Pneumatic Diaphragm Assembly

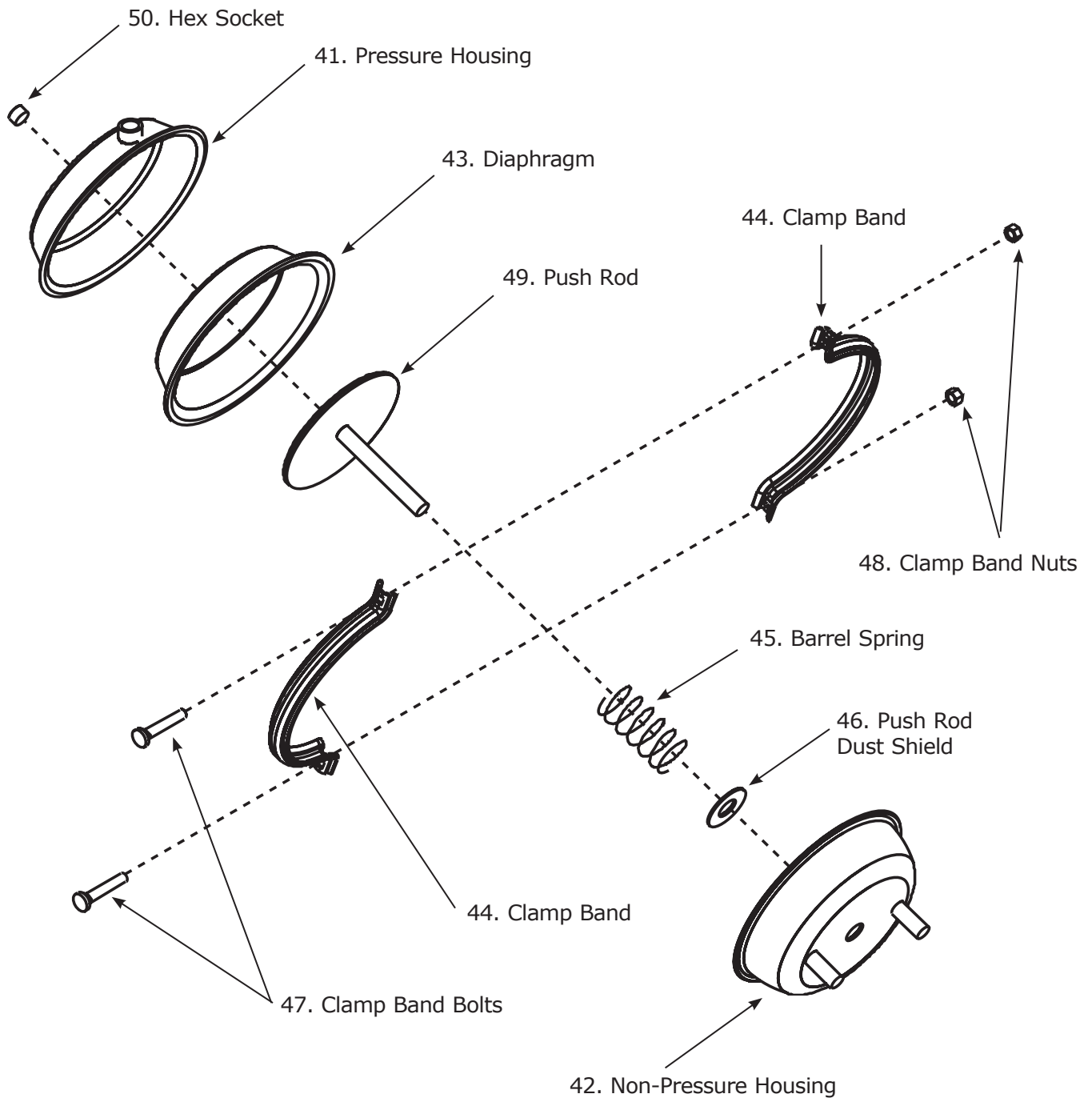

Part No.	Part Name	Part No.	Part Name
41.	Pressure Housing	46.	Push Rod Dust Shield
42.	Non-Pressure Housing	47.	Clamp Band Bolts
43.	Diaphragm	48.	Clamp Band Nuts
44.	Clamp Band	49.	Push Rod
45.	Barrel Spring	50.	Hex Socket

# DeltaGrip Tool Model ASC1

## Disassembly, Inspection and Assembly Instructions

ASC Steel Deck  
A Division of ASC Profiles LLC

### 1. DISCONNECT AIR SUPPLY HOSE

before performing any maintenance to the DeltaGrip Tool.

### 2. Jaw (4) removal:

- a. Pull jaw arm outward and place 3/4" open end wrench around push rod of pneumatic diaphragm assembly (14) between clevis (16) and frame (1).
- b. Remove lock nut (17)
- c. Remove shoulder screw (18)
- d. Remove nylon-insert lock nut (3)
- e. Remove shoulder screw (2)
- f. Check jaw (4), clevis (15), pin (18) and shoulder screw (2) for excessive wear. Excessive wear may be indicated by punch die interference due to excessive pivot hole wear. Replace part(s) if worn beyond use.
- g. Assembly in opposite order.
- h. Apply grease to moving surfaces of shoulder screw (2), jaw (4) and frame (1).
- i. Apply grease to moving surfaces of pin (18), clevis (15) and jaw (4).

### 3. Pneumatic Diaphragm Assembly (14) removal

- a. Disconnect air line by removing hose assembly (11) fitting from adapter (12).
- b. Remove clevis (15)
- c. Remove hex nuts (19).
- d. Pull pneumatic diaphragm assembly (14) off frame.
- e. Assembly in opposite order.

### 4. Handle Assembly (5) removal.

- a. Disconnect air line by removing hose assembly (11) fitting from adapter (12).
- b. Remove nylon-lock nut (18) and hex bolt (16) from frame (1) connection handle assembly (5).
- c. Assemble in opposite order.

### 5. Spool Valve (8), Pressure Relief Valve (10), and Hose Assembly (11) removal.

- a. Remove nylon-lock nut (7) and hex bolts (6) from handle assembly (5) holding spool valve (8).
- b. Remove spool valve (8) from street tee (9).
- c. Remove pressure relief valve (10) from street tee (9).
- d. Remove street tee (9) from air hose assembly (11).
- e. Pull air hose assembly (11) out of handle assembly (5) through lower opening.
- f. Check pressure relief valve (10) by connecting to air supply. If the valve does not relieve pressure at 145 psi replace relief valve. **DO NOT ATTEMPT TO ADJUST OR REPAIR PRESSURE RELIEF VALVE.**
- g. Check spool valve (8), air hose assembly (11), street tee (9) for damage. Replace worn parts.
- h. Assemble in opposite order using pipe thread compound on pipe fittings.

### 6. Disassembling the Pneumatic Diaphragm Assembly (14)

- a. **WARNING** return spring is under pressure and service chamber will spring open when clamp band is released if disassembly instructions are not followed.
- b. Place 5/8 cut washer push rod and thread jam nut (16) onto push rod securing 5/8 washer against pneumatic diaphragm non-pressure housing (42). This will hold return spring in position when clamp band is removed.
- c. Remove clamp band (44) by loosening retaining nuts (48).
- d. Remove rubber diaphragm.
- e. Remove plunger by backing off jam nut (16) to relieve spring plunger.
- f. Remove adapter (12).
- g. Inspect diaphragm (43) and return spring (45) inside pneumatic diaphragm assembly (14). If parts are worn beyond use replace pneumatic diaphragm assembly (14).
- h. Assemble in opposite order, use pipe thread compound on threads of adapter (12).

# Daily Maintenance and Lubrication Instructions

## Punch and Die

1. Scrape off build up of zinc from galvanizing or other foreign material as required to maintain a good quality punch.
2. Replace punch when edges are worn or fractured to a point where a good quality punch in the seam cannot be achieved.
3. Replace die when edges are worn to a point where a good quality punch in the seam cannot be achieved.

## Jaw

Lubricate pivot points with heavy service grease using zirk fittings in pivot shoulder screw (2) and clevis shoulder screw (17). Wipe off excess grease.

## Control Valve

Lubricate control valve with a drop of air tool oil in air fitting (13) as required to maintain friction free motion of trigger. Excessive lubrication is not recommended.

## Accessories

All accessories are individually packaged with mounting screws and hex key.

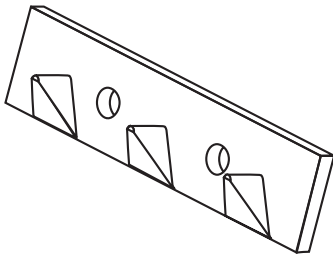

DeltaGrip Punch

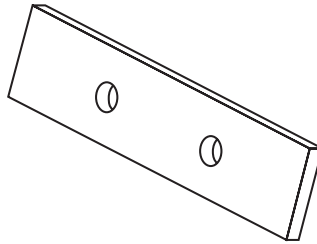

Crimping Punch  
(1/8" thick plate)

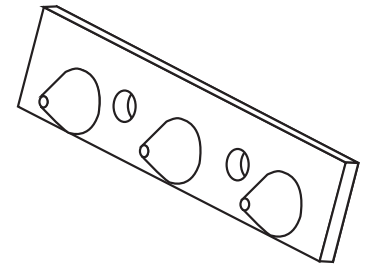

Button Punch

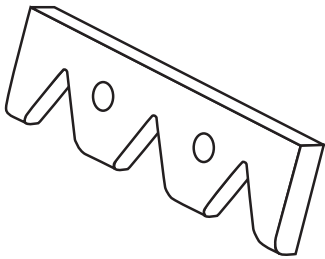

DeltaGrip Die

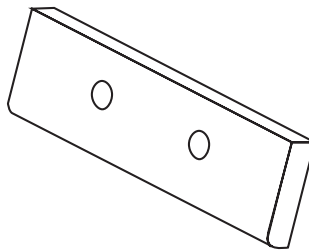

Crimping Die  
(1/4" thick plate)

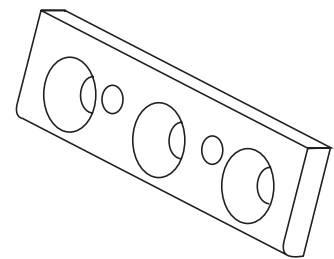

Button Punch Die

## Limited Warranty

90 Day Limited Warranty: ASC Steel Deck will repair defects to the Delta Grip Tool due to faulty materials or workmanship at no cost to the user for a period of 90 days from the date the DeltaGrip Tool is shipped. This limited warranty excludes dies, punches and normal wear and tear.



2110 Enterprise Boulevard, West Sacramento, CA 95691  
Toll: 1-800-726-2727; Tel 916-372-2851; Fax 916-372-7606

©2008-2014 ASC Profiles LLC. All rights reserved.  
February 2014  
US Patent No.'s: 7,021,108; 6,990,781